



MX SERIES

MEDICAL FURNITURE & HOSPITAL EQUIPMENT



Machan International Co., Ltd. is the parent company of BAILIDA and a manufacturer of professional tool storage units with a well earned international reputation for quality and service. For over 35 years we have been providing uniquely designed and high quality tool storage products to customers internationally. We are located in Taiwan, and were founded in 1976.

BAILIDA is our latest brand of hospital equipment. BAILIDA hospital equipment products include:

- Medical carts
- Medication carts
- Emergency / crash carts
- Utility trolleys
- Hospital equipment
- Hospital storage units and accessories

We also provide custom OEM/ODM services. BAILIDA is the transliteration of the Chinese meaning "100% of our best" for you. This is BAILIDA's essential spirit. And we take advantage of our strong Research and Development and Quality Management teams to provide you with OEM/ODM services and custom products.

BAILIDA is still young in the hospital equipment market but we are full of energy. In order to achieve 100% of our best, we leverage our creativity, efficiency, quality, stylish design and professional service to continually offer innovative and useful products.

Make BAILIDA your first choice for hospital equipment. Whether products or services, we promise to give you 100% of our best.

1	Features of the MX Series
3	Crash / emergency cart
5	Anesthesia cart
7	Procedure cart
9	Isolation cart
11	Storage cabinet
13	File cart
15	Double medical cart
17	Med-bin cart
19	Accessory list
21	Divider system package
23	Open trolley range
25	Bedside Cabinet
27	Electronic touchpad locking system

NC & MI SERIES

28~32

29	Narrow cart
32	Mini cart

MF SERIES

33~47

34	IV pole stand
35	Func-cart series
41	Utility cart
43	Equipment cart
45	Clean linen trolley
46	Overbed table
47	Pediatric emergency cart



100% of our best for you

FEATURES OF THE MX SERIES

Powder paint

4 main colours, other colour options available

- Anti-static paint available
- Anti-static and anti-bacterial paints available

You can choose more than just colours.
The cart can be a part of your stylish furniture.

- Wood grain design
- Garden & Sea sticker design for kids hospital

4 main colours	Other available colours
 White	 Cream
 Yellow	 Bright orange
 Red	 Blush pink
 Blue	 Lavender
	 Light blue
	 Fresh green



ABS top surface
Light, easy to clean.



Push handle
User friendly design, height adjustable, easy set up.

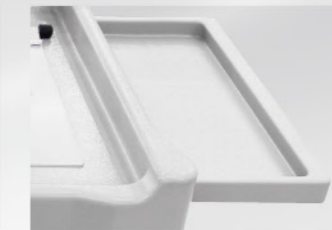

Sliding table
455x360mm
Easy to use, space saving, max load 5kg



Central lock
secures all drawers



MIS (Make It Safe)

Rail options



Auto return (standard)



Soft return (light & quiet)

Drawer specifications

A Drawer
W569 x D398 x H76 (3")

B Drawer
W569 x D398 x H155 (6")

C Drawer
W569 x D398 x H234 (9")

Divider system

Clearly sorts and organises medicines

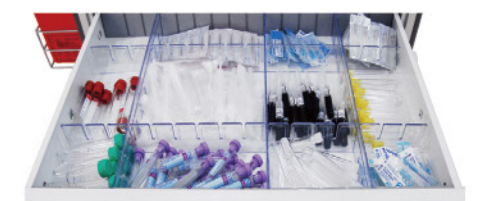

4 available cart heights: 28", 31", 34", 37"
(w/o 5" Casters)



Aluminium frame

Light, protects cart body, different sign line colour options indicate cart functions.

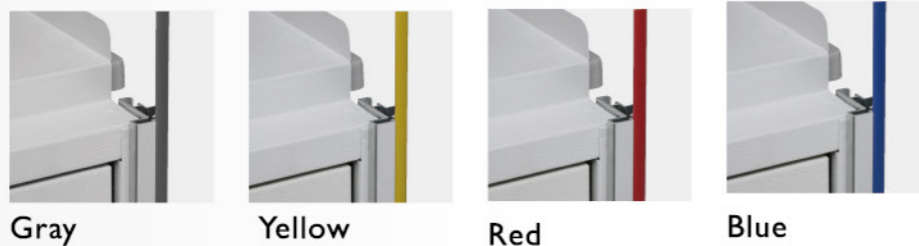

Caster options

Size: 5" (ø125mm)
Caster and drawer options are available to satisfy different customer requirements.

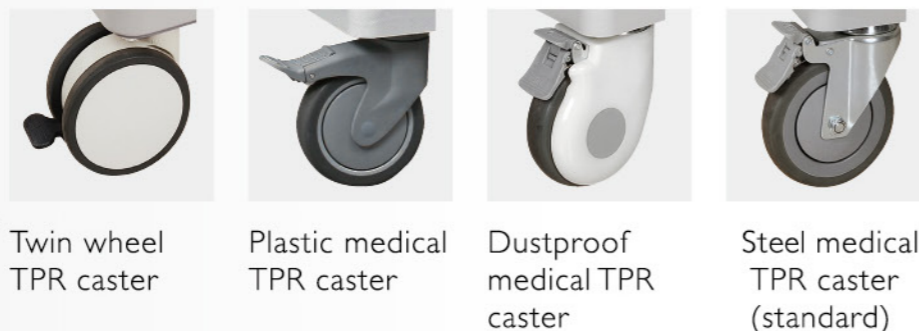



CRASH / EMERGENCY CARTS

MX Emergency / Crash Carts were designed with input from emergency room professionals to deliver the ultimate in convenience and safety. These carts define a new standard of organization and function with specialised accessories for every emergency response. This series offers stable, smooth mobility and enhanced convenience with changeable accessories, as well as a breakaway lock for that little bit extra.



SPECIFICATIONS

	MX28EMG		MX31EMG		MX34EMG		MX37EMG	
	mm	inch	mm	inch	mm	inch	mm	inch
W	690	27.2	690	27.2	690	27.2	690	27.2
D	518	20.4	518	20.4	518	20.4	518	20.4
H	848	33.4	927	36.5	1006	39.6	1085	42.7
H (w/o 5" Casters)	714	28.1	793	31.2	872	34.3	951	37.4



2 Defibrillator shelf is able to turn 360° and lock tight during transportation.

Breakaway lock
2 options



First drawer only



Locking bar for all drawers

STANDARD ACCESSORIES

- 1** IV pole
- 2** Defibrillator shelf
- 3** CPR board
- 4** Oxygen tank holder
- 5** Sharps container set



CPR board
Macromolecular polymer CPR board is strong and easy to clean.



Oxygen tank holder
Adjustable ties securely fasten the oxygen tank.



Sharps container set



ANESTHESIA CARTS

MX Anesthesia Carts were designed with a combination of functions and technology specific to the needs of the anesthesia department. This series offers a wide choice of accessories to personalise carts for every possible situation. The top narcotics drawer locks to ensure medications are secure at all times.



SPECIFICATIONS

	MX28ANE		MX31ANE		MX34ANE		MX37ANE	
	mm	inch	mm	inch	mm	inch	mm	inch
W	690	27.2	690	27.2	690	27.2	690	27.2
D	518	20.4	518	20.4	518	20.4	518	20.4
H	848	33.4	927	36.5	1006	39.6	1085	42.7
H (w/o 5" Casters)	714	28.1	793	31.2	872	34.3	951	37.4



Tilt bin organisers
Numerous multi-functional top shelf storage options attach to the bridge for quick access.

Bulk storage bins

Full locking narcotics drawer
Locking narcotics drawer provides extra control and protection for anesthetic medications.



Drawer dividers
are adjustable and removable.



STANDARD ACCESSORIES

- 1 IV pole
- 2 Tilt bin organisers (S)
- 3 Tilt bin organisers (L)
- 4 Accessory bridge
- 5 Glove dispenser
- 6 Sharps container set
- 7 Waste container w/ lid



Accessory bridge

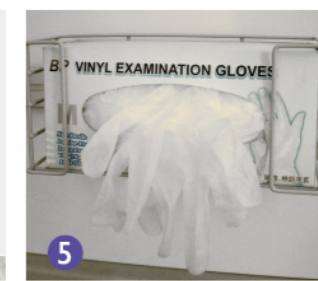

Glove dispenser



Sharps container set



PROCEDURE CARTS

MX Procedure Carts can be arranged to suit a multitude of medical departments & situations.

- | | |
|--------------------|---------------|
| Supply and storage | Bio-medical |
| Surgical | IV |
| Castings | Critical care |
| Dressings | Trauma |
| Airways | Lab |



SPECIFICATIONS

	MX28PRO		MX31PRO		MX34PRO		MX37PRO	
	mm	inch	mm	inch	mm	inch	mm	inch
W	690	27.2	690	27.2	690	27.2	690	27.2
D	518	20.4	518	20.4	518	20.4	518	20.4
H	848	33.4	927	36.5	1006	39.6	1085	42.7
H (w/o 5" Casters)	714	28.1	793	31.2	872	34.3	951	37.4



IV pole
Adjustable IV pole



Computer drawer is available for all carts.



Accessory combinations
Easy to adjust accessories can be set up to suit a variety of requirements.



STANDARD ACCESSORIES

- 1 IV pole
- 2 Multi storage (L)
- 3 Waste container w/ lid
- 4 Sharps container set

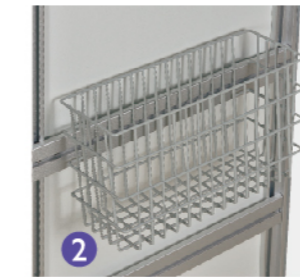

Multi storage (L)



Waste container w/ lid



Sharps container set

ISOLATION CARTS

MX Isolation Carts were designed with bright yellow drawers to alert staff and visitors. This series is available with non-locking drawers, central locking drawers, or individually locking drawers. Typical accessory options include deep drawers for bulky supplies (gowns, caps, gloves, etc.) and a built-in aluminium frame with yellow sign line.



SPECIFICATIONS

	MX28ISO		MX31ISO		MX34ISO		MX37ISO	
	mm	inch	mm	inch	mm	inch	mm	inch
W	690	27.2	690	27.2	690	27.2	690	27.2
D	518	20.4	518	20.4	518	20.4	518	20.4
H	848	33.4	927	36.5	1006	39.6	1085	42.7
H (w/o 5" Casters)	714	28.1	793	31.2	872	34.3	951	37.4



Drawers & dividers
Strong drawers with large storage capacity easily store large expendables and other supplies.



Accessory combinations
Height adjustable accessories can be set up to suit any requirement.

STANDARD ACCESSORIES

- 1 Multi storage (L)
- 2 Waste container w/ lid
- 3 Glove dispenser



Multi storage (L)



Waste container w/ lid



Glove dispenser



STORAGE CABINET

With the top quality construction, the storage cabinet creates ideal workspace and solutions of secure storage to keep you organized. The mobile cart availability provides you the flexibility everywhere. Different accessory combinations can be selected and assembled.



MX3101SC

MX3402SC

MX3703SC

SPECIFICATIONS

	mm	inch	mm	inch	mm	inch
W	690	27.2	690	27.2	690	27.2
D	518	20.4	518	20.4	518	20.4
H	927	36.5	1006	39.6	1085	42.7
H (w/o 5" Casters)	793	31.2	872	34.3	951	37.4



Drawers & dividers
Strong drawers with large storage capacity easily store large expendables and other supplies.



Locking door keeps storage secure

- Metal construction with durable powder coating
- 4 aluminium frames
- ABS top, pull-out work table, push handle
- Central key lock design
- One adjustable layer inside
- Standard 5" iron casters
(2 w/ brake, 1 free, 1 w/ direction control)



(File divider design is available, max 19 dividers, MDF material (Medium density fiberboard))

FILE CARTS

MX File Carts were designed for efficient use, speedy delivery, and to fit different document sizes.



Features

- ABS top w/ sliding extension
- 12" high drawer x 2
- Central lock and key
 - 5" TPR caster



Features

- ABS top w/ sliding extension
- 15" high door w/ handle
- 10 wire dividers
- 12" high drawer
- 5" TPR caster

Divider



Divider level adjusts to fit different document sizes.

SPECIFICATIONS

MX31FDT

	mm	inch
W	690	27.2
D	518	20.4
H	927	36.5
H (w/o 5" Casters)	793	31.2

Drawer

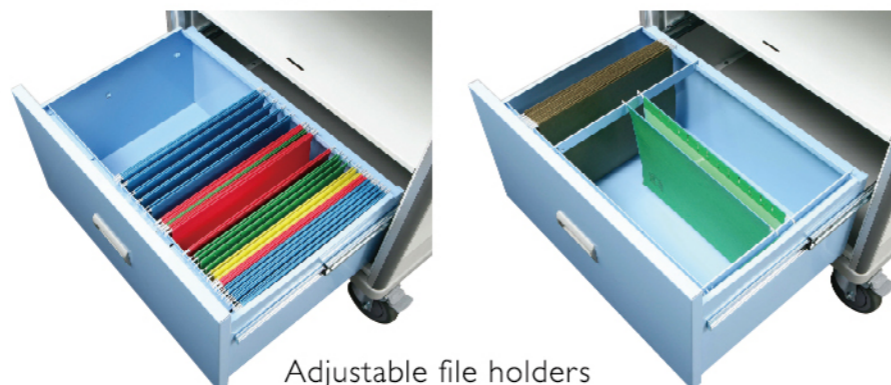

Adjustable file holders can be set at different positions.

SPECIFICATIONS

MX34FDT

	mm	inch
W	690	27.2
D	518	20.4
H	1006	39.6
H (w/o 5" Casters)	872	34.3



Locking door keeps documents secure

DOUBLE MEDICAL CART

This double medical cart provides large space for storage and organizes medicines easily and clearly. The key lock design secures all drawers. It also offers stable, smooth mobility and enhanced convenience with changeable accessories to meet your needs.

VTB-2-DX

(18 tilt bins (S)+1010.5mm rail(VPR-4)x2)



VBS-DX

(Bulk storage bin x 9+one metal hanger +1010.5mm rail (VPR-4)x1)



(Door w/shelves is available)



DX34

A drawer dimension

W569 x D398 x H76mm (3")
 W569 x D398 x H155mm (6")
 W569 x D398 x H234mm (9")
 3" divider sets: P-FD3 / P-AD3
 6" divider sets: P-FD6 / P-AD6

B drawer dimension

W399 x D398 x H76mm (3")
 W399 x D398 x H155mm (6")
 W399 x D398 x H234mm (9")
 3" divider sets: N-FD3 / N-AD3
 6" divider sets: N-FD6 / N-AD6

Drawer combination

You can select different drawer combinations within the limited height 27".

SPECIFICATIONS

DX34

	mm	inch
W	1125	44.3
D	545	21.5
H	1010	39.8
H (w/o 5" Casters)	885	34.8

Features

- Metal construction with powder coating
- 4 aluminum frames
- ABS top, pull-out work table & push handle
- Central key lock design
- Standard 5" iron casters

(1 free, 1 w/direction control, 2 w/brake)



SCREEN HOLDER

If using PC monitor, you can choose VVP or VLP to assemble on the right side of carts. It is height adjustable.

- Part no. VLP includes 2 + 3
- Part no. VVP includes 1 + 2

NOTEBOOK HOLDER

If using the notebook, you can choose

- Part no. VLN includes 2 + 3 + 4
- Part no. VVN includes 1 + 2 + 4

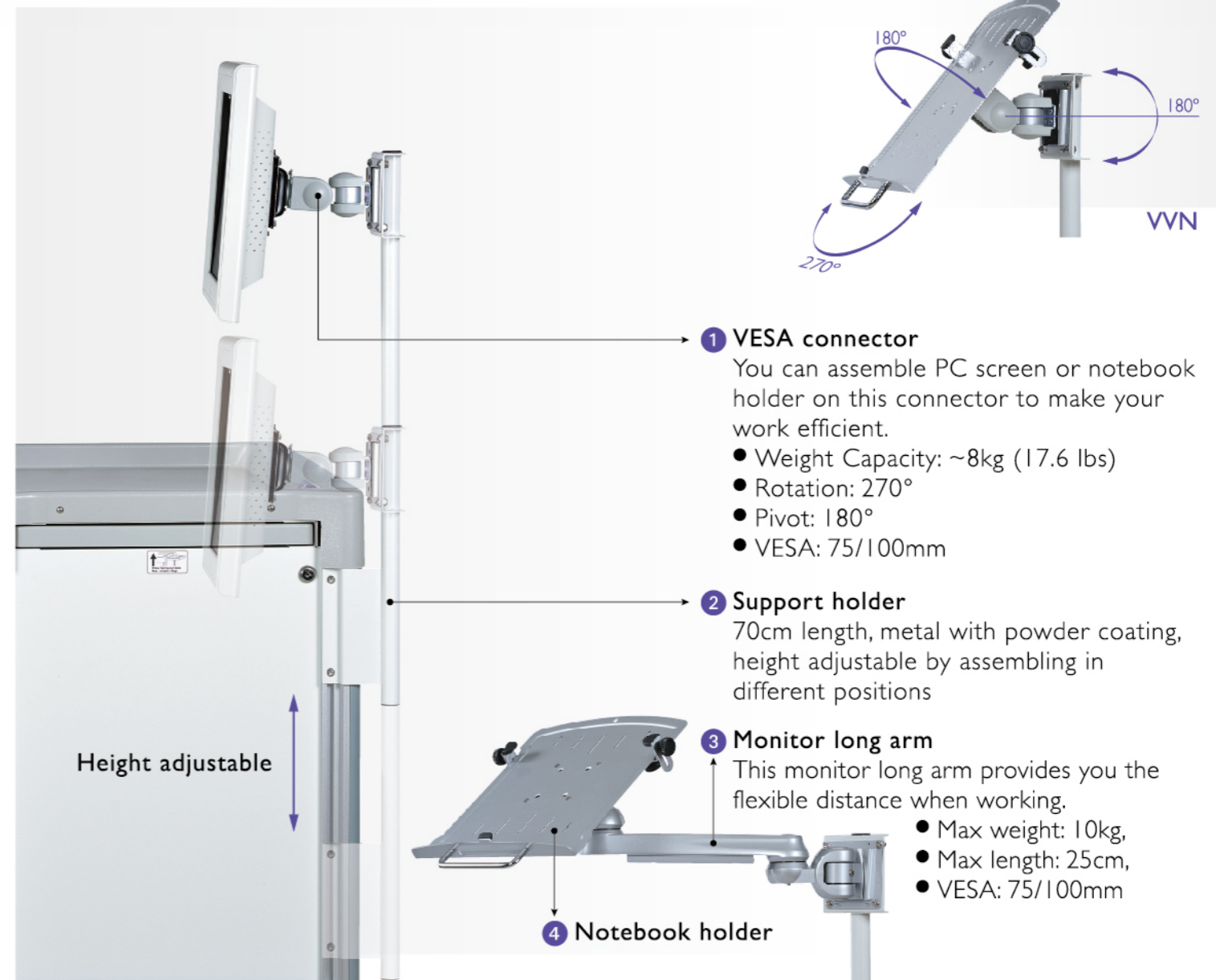

1 VESA connector

You can assemble PC screen or notebook holder on this connector to make your work efficient.

- Weight Capacity: ~8kg (17.6 lbs)
- Rotation: 270°
- Pivot: 180°
- VESA: 75/100mm

2 Support holder

70cm length, metal with powder coating, height adjustable by assembling in different positions

3 Monitor long arm

This monitor long arm provides you the flexible distance when working.

- Max weight: 10kg,
- Max length: 25cm,
- VESA: 75/100mm

4 Notebook holder

MED-BIN CARTS

Med-bin carts with double-side bin drawers make the supply of medicines efficient and convenient.

- Metal with powder coating
 - Central key lock at side to secure all drawers
 - Drawer combination: 3" drawer x 1 + 3" bin drawer x 2 + 3" drawer x 1 + 6" drawer x 1 + 9" drawer x 1
 - Total 3" ABS bin x 20pcs, 3" bin drawer x 2 rows x 2 sides (5 bins per row x 2 rows x 2 sides)
 - 5" steel casters (Standard) (2 w/brake, 1 w/direction control, 1 free)
- w/5" steel casters ←



(w/5" dustproof casters)

Double sided bin drawers make supplying medicines fast and efficient.



ABS bins

3" height (W112 x D215 x H75mm)
ABS bins with 2 removable PS dividers easily separate medicines and supply for any need.



- Metal with powder coating
- Each ABS bin can be pulled out individually from both sides
- Central key lock at side to secure all bins and drawers
- ABS bin no.: you can select 20/ 30/ 40 & 50 bins (double sides)
- 5" steel casters (standard) (2 w/ brake, 1 w/direction control, 1 free)



MBI 3722 (6" bin x 20) (+ 6" drawer x 1 + 9" drawer x 1)



MBI 3731 (6" bin x 30) (+ 9" drawer x 1)



MBI 4241 (6" bin x 40) (+ 6" drawer x 1)



MBI 4250 (6" bin x 50)



- ABS bin dimension: 6" height (W 112 x D 215 x H 154 mm)
- All ABS bins can be secure by central key lock control.
- There are 2 x PS dividers in each ABS bin. It can organize medicines efficiently.



(Back)

SPECIFICATIONS

MB3424

	mm	inch
W	690	27.2
D	540	21.3
H	1010	39.8
H (w/o 5" Casters)	885	34.8

SPECIFICATIONS

MBI 3722

MBI 3731

MBI 4241

MBI 4250

	mm	inch	mm	inch	mm	inch	mm	inch
W	690	27.2	690	27.2	690	27.2	690	27.2
D	540	21.3	540	21.3	540	21.3	540	21.3
H	1100	43.3	1100	43.3	1229	48.4	1229	48.4
H (w/o 5" Casters)	940	37	940	37	1070	42.1	1070	42.1

ACCESSORY LIST

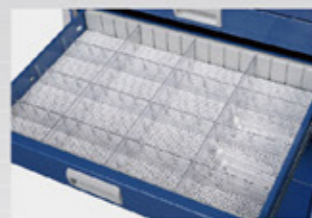

VNS
(Non-slip mat)
560 x 345 mm



VTS
(Top shelf at back)
540 x 150 x 50 mm

Top accessories



VIV
IV pole



VDS
Defibrillator shelf
355 x 355 ~ 415mm



VTB-2
Tilt bin organiser (S)
598 x 86 x 250mm



VTB-1
Tilt bin organiser (L)
598 x 102 x 149mm



P-AB
Accessory bridge
800mm



VBS-I & VPR-I
Bulk storage bins (L)
& back rail
75 x 105 x 190mm



VGD & VPR-I
Glove dispenser &
back rail
160 x 135 x 95mm



VBH & VPR-I
Bottle holder &
back rail
355 x 95 x 80mm

Rear accessories



VCPR & VHK
CPR cardiac board &
hooks
440 x 510 x 10mm



VMH
Magnetic label holder
L80 x W50 x T5mm
6pcs/pack



VPT
Pull-tite seal in pink
w/ serial no., 50pcs/pack



VPS
Plastic seal in red
w/ serial no., 50pcs/pack

Others

Side accessories



VGD & VPR-2
Glove dispenser &
side rail
265x85x130mm



VSC & VPR-2
Sharps container &
side rail
105x130x215mm



VBH & VPR-2
Bottle holder &
side rail
315x110x75mm



VMS & VPR-2
Multi-storage (L) &
side rail
320x120x180mm



VWC & VPR-2
Waste container w/ lid &
side rail
255 x 170 x 315mm



VWB & VPR-2
Waste bin & side rail
265 x 255 x 460mm



VGB & VPR-2
Garbage bin & side rail
255 x 170 x 315mm



VFH & VPR-2
File holder & side rail
320 x 118 x 250mm



VO2 & VPR-2
Oxygen tank holder &
side rail
145 x 125 x 403mm



VCH & VPR-2
Catheter holder &
side rail
100 x 100 x 480mm



VSH & VPR-2
Suction machine holder &
side rail
213 x 395 x 115mm



VDH & VPR-2
Documents holder &
side rail
330 x 160 x 255mm



VSD
Side drawer set, for
34" & 37" only,
450 x 120 x 665mm



VBP & VPR-2
Bumper set



VVP
Screen holder set,
short arm



VLP
Screen holder set,
long arm

DIVIDER SYSTEM PACKAGE

Fixed divider set



P-FD3

3" fixed divider set in drawer
(3 x short + 3 x fixed + 2 x 3" strip)

3" fixed divider set
(3 x short + 3 x fixed)

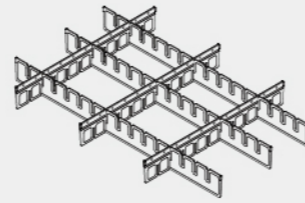

P-FT3



P-FD6

6" fixed divider set in drawer
(2 x short + 2 x fixed + 2 x 6" strip)

6" fixed divider set
(2 x short + 2 x fixed)

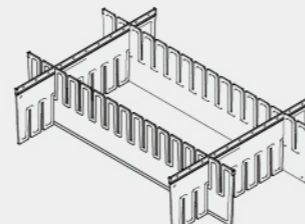

P-FT6

Adjustable divider set (Length adjustable)



P-AD3

3" adjustable divider set in drawer
(3 x short + 6 x adjustable + 2 x 3" strip + 6 x T clips)

3" adjustable divider set
(3 x short + 6 x adjustable + 6 x T clips)

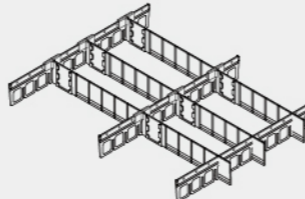

P-AT3

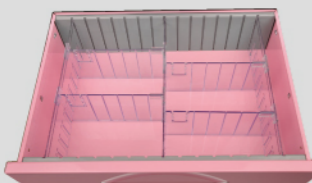

P-AD6

6" adjustable divider set in drawer
(3 x short + 4 x adjustable + 2 x 6" strip + 4 x T clips)

6" adjustable divider set
(3 x short + 4 x adjustable + 4 x T clips)

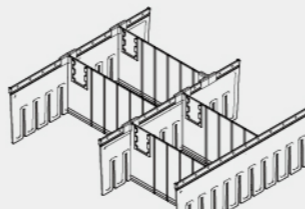

P-AT6

3" Individual divider

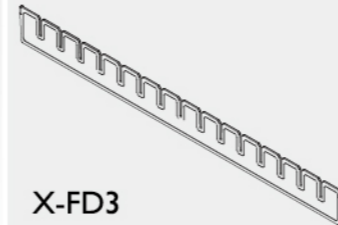

X-FD3

3" Fixed divider
542 x 51 mm

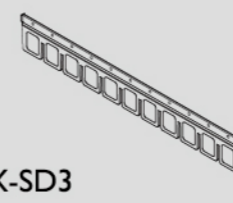

X-SD3

3" Short divider
368 x 51 mm

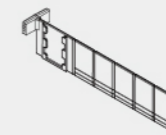

X-AD3

3" Adjustable divider
237 x 51 mm

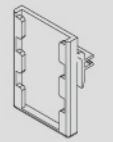

X-LH

Label holder
40 x 60 mm
20 pcs/pack

6" Individual divider

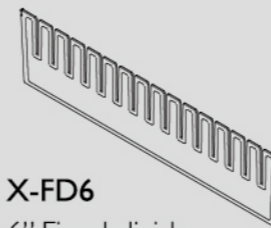

X-FD6

6" Fixed divider
542 x 130 mm

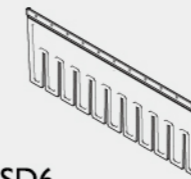

X-SD6

6" Short divider
368 x 130 mm



X-AD6

6" Adjustable divider
237 x 130 mm

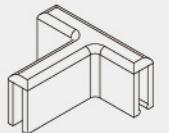

XTC

T clip
40 x 36 mm
10 pcs/pack

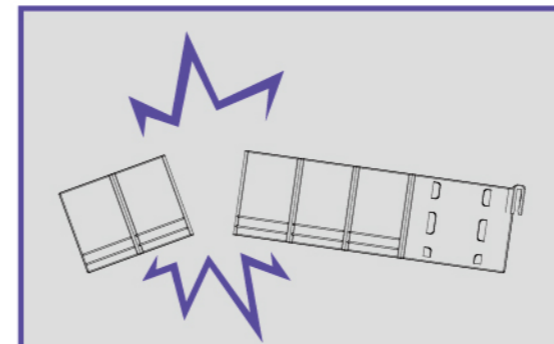

The length of the adjustable divider can be changed with a snap.

After snapping, the length of the adjustable divider cannot restore to the original.

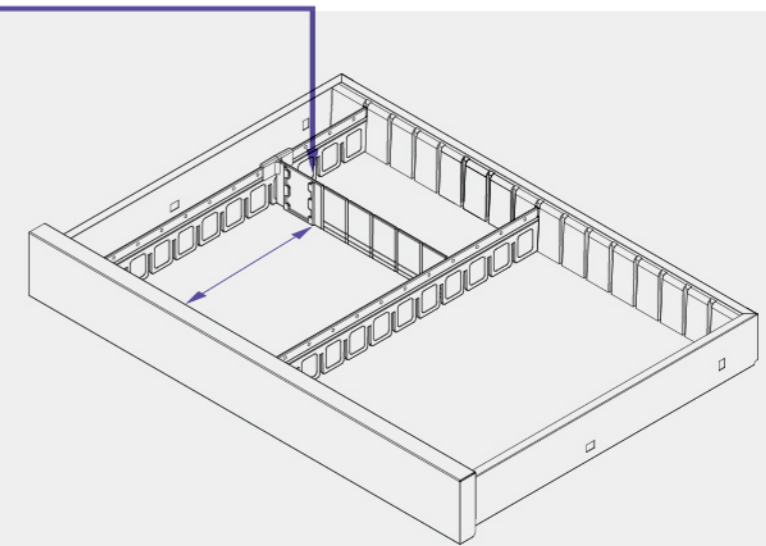

OPEN TROLLEY RANGE

Bailida open trolley range was designed for use in clean designated areas and for medicine transportation. Different accessories can be assembled on both sides of the trolley. This range is available with white frames, 3" & 6" blue ABS trays, and single or double columns at different trolley heights. The bumper design protects the user and the trolley well.



OT-S2



ABS trays

- 3" & 6" are available.
- Trays can be pulled out from both sides.
- Divider system clearly sorts medicines in ABS trays.



w/o push handle



w/ push handle



OT-D2

SPECIFICATIONS

	OT-S1 (w/o push handle)		OT-S2 (w/ push handle)		OT-S3 (w/o push handle)		OT-D1 (w/o push handle)		OT-D2 (w/ push handle)		OT-D3 (w/o push handle)	
	mm	inch	mm	inch	mm	inch	mm	inch	mm	inch	mm	inch
W	659	26	659	26	659	26	891	35	891	35	891	35
D	406	16	406	16	406	16	606	24	606	24	606	24
H	822	32	1070	42	1454	57	822	32	1070	42	1454	57
H (w/o 4" Casters)	665	26	913	36	1297	51	665	26	913	36	1297	51
Tray / Basket Combination	457	18	610	24	1067	42	457 x 2	18 x 2	610 x 2	24 x 2	1067 x 2	42 x 2

BEDSIDE CABINET



Features

- ABS body, top & drawer
- 2" plastic casters



BC35GR



Features

- Metal powder coated body
- ABS top, sliding work surface
- Single drawer with key lock
- Recessed front facing w/ one adjustable layer inside for storage
- Stainless towel holders on both sides
- Available colours: light pink / light blue
- Other colours: available with MOQ
- 2" plastic casters

BC30PK



BC37BL



SPECIFICATIONS

	BC30PK		BC35GR		BC37BL	
	mm	inch	mm	inch	mm	inch
W	460	18.1	460	18.1	460	18.1
D	508	20	460	18.1	508	20
H (w/ 2" Casters)	760	29.9	870	34.3	930	36.6

ELECTRONIC TOUCHPAD LOCKING SYSTEM



- Under one master ID no. and code, there are total 100 ID (001~100) can be used. Each ID has its password which includes 4 number digits. The User history data can be downloaded via USB port to save or view on PC.
- You need to key in 4 number digits to open after setting.
- When pressing any button, LED "Key in" will light up in blue once to confirm the status.
- You can press "Lock" button to lock directly or wait for auto-lock at setting time.
- The central key lock can be used if the touchpad locking system is broken or out of battery.
- When logging in the software, you can add, delete, change password and track using records.
- Battery: Type C battery x 6pcs. Battery low LED will light up when it is low.

SPECIFICATIONS

MXE34

	mm	inch
W	690	27.2
D	518	20.4
H	1006	39.6
H (w/o 5" Casters)	872	34.3



NC & MI SERIES
 MEDICAL FURNITURE & HOSPITAL EQUIPMENT

FEATURES OF THE NC SERIES

Powder paint

4 main colours, other colour options available

- Anti-static paint available
- Anti-static and anti-bacterial paints available

Features

- ABS top & bumpers
- Central key lock to secure all drawers
- Push handle

4 main colours



Other available colours

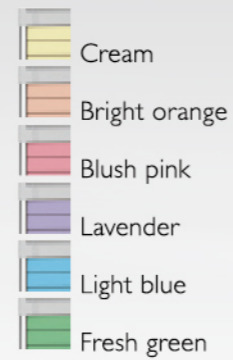

Computer drawer is available

Drawer specifications



3" Drawer

Outer: W 399 x D 398 x H 76 mm
Inner: W 353 x D 385 x H 56 mm



6" Drawer

Outer: W 399 x D 398 x H 155 mm
Inner: W 353 x D 385 x H 134 mm



9" Drawer

Outer: W 399 x D 398 x H 234 mm
Inner: W 353 x D 385 x H 213 mm

Drawer divider set for NC series



3" Drawer dividers
(3 x short + 6 x adjustable + 2 x 3" strip + 6 x T clips)

N-AD3



6" Drawer dividers
(3 x short + 4 x adjustable + 2 x 6" strip + 4 x T clips)

N-AD6

Screen & notebook holders for NC series



VLP
Screen holder w/ long arm

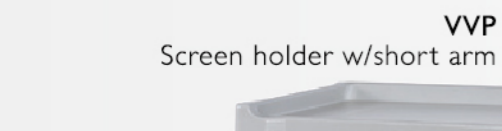

VVP
Screen holder w/ short arm

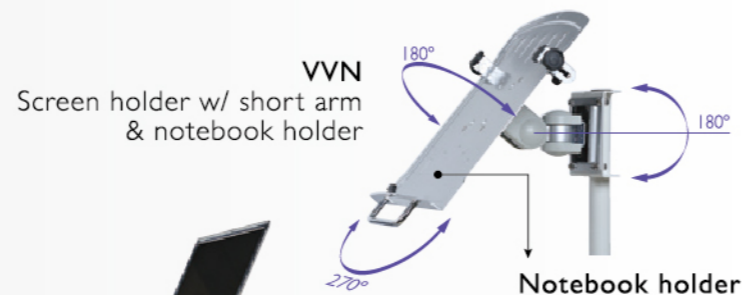

VVN
Screen holder w/ short arm
& notebook holder



VLN
Screen holder w/ long arm
& notebook holder

NARROW CARTS

This narrow cart is designed with smaller overall dimensions and ideal for areas with limited space. It provides convenient storage and easy movement with different accessory options. Central key lock controls offers the necessary security on this lightweight and versatile unit.



NC3405



VTB-2-NC-A
(12 tilt bin(S)+400mm rail x1)



NC3706

SPECIFICATIONS

SPECIFICATIONS	NC3405		NC3706	
	mm	inch	mm	inch
Drawer 3"-6"-9"	2-2-1		3-2-1	
W (inc. bumper)	510	20.0	510	20.0
D (inc. bumper)	542	21.3	542	21.3
H	977	37.2	1056	41.6
H (w/o 4" casters)	842	33.2	921	36.3

ACCESSORY LIST



VIV
IV pole



VDS
Defibrillator shelf
355 x 355 ~ 415mm



VCPR & VHK
CPR cardiac board & hooks
440 x 510 x 10mm



VMH
Magnetic label holder
L80 x W50 x T5mm
6pcs/pack



VPT
Pull-tite seal in pink
w/ serial no., 50pcs/pack



VPS
Plastic seal in red
w/ serial no., 50pcs/pack

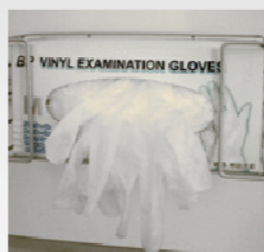

VGD & VPR-2
Glove dispenser & side rail



VSC & VPR-2
Sharps container & side rail



VBH & VPR-2
Bottle holder & side rail



VMS & VPR-2
Multi-storage (L) & side rail



VWC & VPR-2
Waste container w/ lid & side rail
255 x 170 x 315mm



VWB & VPR-2
Waste bin & side rail
265 x 255 x 460mm



VGB & VPR-2
Garbage bin & side rail
255 x 170 x 315mm



VFH & VPR-2
File holder & side rail
571 x 397 x 150mm



VCH & VPR-2
Catheter holder & side rail
100 x 100 x 480mm

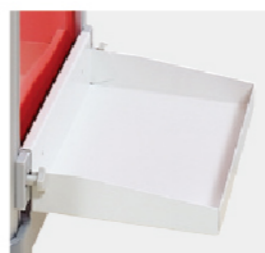

VSH & VPR-2
Suction machine holder & side rail
213 x 395 x 115mm



VDH & VPR-2
Documents holder & side rail
330 x 160 x 255mm



VO2 & VPR-2
Oxygen tank holder & side rail
145 x 125 x 403mm



VSD
Side drawer set, for 34" & 37" only,
450 x 120 x 665mm



VTS-NC
(Top shelf-NC)
345 x 154 x 54mm



VVP
Screen holder set,
short arm



VLP
Screen holder set,
long arm

MINI CARTS

It especially provides the movable storage for areas with limited space. The design of central key lock can secure all drawers. You also can choose different colors to match your interior design.
(Not able to assemble accessories)

Drawer divider set for MI series



N-AD3
3" Drawer dividers
(3 x short + 6 x adjustable + 2 x 3" strip + 6 x T clips)



N-AD6
6" Drawer dividers
(3 x short + 4 x adjustable + 2 x 6" strip + 4 x T clips)



Foldable table is available



SPECIFICATIONS

SPECIFICATIONS	MI 3105		MI 3405		MI 3706	
	mm	inch	mm	inch	mm	inch
Drawer 3"-6"-9"	3-1-1		2-2-1		3-2-1	
W (inc. bumper)	520	20.4	520	20.4	520	20.4
D (inc. bumper)	540	21.2	540	21.2	540	21.2
H	867	34.1	946	37.2	1025	40.3
H (w/o 4" Caster)	732	28.8	811	31.9	890	35.0

IV POLE STAND

Durable material, stylish design with high mobility match different hospital environment.

- Pole: electroplate pole (outer: 25mm/ Inner: 19mm)
- Height adjustment: 1,225mm ~ 2,150mm (top to ground)
- Hook: 4 hooks (2 hooks removable)
- Base: diameter 480mm, PP & fiber, black
- Casters: 2" plastic free casters x 5
- Optional accessories



IV01

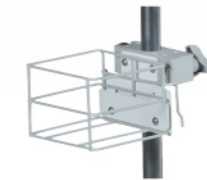

ISB
Basket only
(W120 x D120 x H90mm)

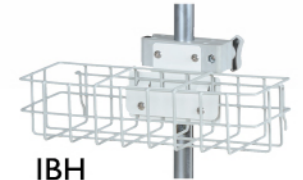

IBH
Bottle holder



ISC
Sharp container



IGD
Glove dispenser



IPH
Push handle
(diameter: 25mm)



IVO2
Oxygen
tank holder

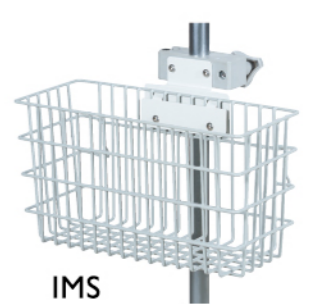

IMS
Multi storage (L)



FUNC-CART SERIES

Func-Cart Double-Face medication trolleys make sorting and moving a variety of medications convenient. This series is perfect for transporting and sorting medications in hospitals, clinics, nursing homes, health centers and medical centers.



FC2703L

- PP worktop and handles
- Aluminium frame
- ABS side panels
- Central key lock control
- 4" TPR casters
- 3" drawer x 2
- 6" drawer x 1



FC2704L

- PP worktop and handles
- Aluminium frame
- ABS side panels
- Central key lock control
- 4" TPR casters
- 3" drawer x 2
- 6" drawer x 1
- 9" drawer x 1

SPECIFICATIONS	FC2703L		FC2704L	
	mm	inch	mm	inch
W	760	29.9	760	29.9
D	490	19.3	490	19.3
H	930	36.6	930	36.6
H (w/o 4" caster)	830	32.6	830	32.6



Mount accessories on both sides.

ACCESSORY LIST

Side Accessories

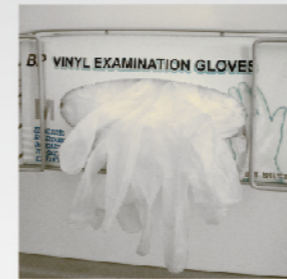

VGD & VPR-3
Glove dispenser & side rail



VSC & VPR-3
Sharps container & side rail

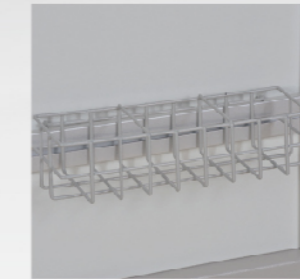

VBH & VPR-3
Bottle holder & side rail



VMS & VPR-3
Multi-storage (L) & side rail



VWC & VPR-3
Waste container w/lid & side rail
255 x 170 x 315mm



VWB & VPR-3
Waste bin & side rail
265 x 255 x 460mm



VGB & VPR-3
Garbage bin & side rail
255 x 170 x 315mm



VFH & VPR-3
File holder & side rail
320 x 118 x 250mm



VCH & VPR-3
Catheter holder & side rail



VDH & VPR-3
Documents holder & side rail
330 x 160 x 255mm



4" plastic casters
(available for FC series)

Foldable Basket



W484 x D352 x H50mm



PP capacity : 20kg



W484 x D352 x H231mm



Double sided drawers make supplying medicines while on the go fast and efficient.

- PP worktop and handles
- Aluminium frame
- Central key lock control on both sides
- ABS side panels
- 4" TPR casters (2 w/ brake)
- 3" bin drawer x 2 rows per side
3" ABS bin x 20pcs
(5pcs per row x 2 rows x 2 sides)
- 6" bin drawer x 1 row per side
6" ABS bin x 10pcs
(5pcs per row x 1 row x 2 sides)
- 6" drawer x 1 + 9" drawer x 1



FC3432DXL

ABS Bin

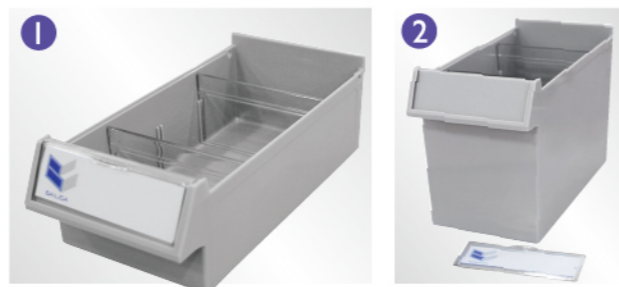

ABS bins with PS dividers come in 2 sizes and easily separate medicines and supplies for just about any need.

- 1 3" Height (W 112 x D 215 x H 75 mm)
- 2 6" Height (W 112 x D 215 x H 154 mm)



Mount accessories on both sides.

SPECIFICATIONS	FC3432DXL	
	mm	inch
W	760	29.9
D	490	19.3
H	1090	42.9
H (w/o 4" caster)	990	39.1



FC3440DXL



ABS bins are easy to remove and replace.

Drawers



Strong drawers with large spaces easily accommodate large expendables and supplies.

- PP worktop and handles
- Aluminium frame
- Central key lock control on both sides
- ABS side panels
- 4" TPR casters (2 w/ brake)
3" bin drawer x 2 rows per side
3" ABS bin x 20pcs
(5pcs per row x 2 rows x 2 sides)
- 6" bin drawer x 2 rows per side
6" ABS bin x 20pcs
(5pcs per row x 2 rows x 2 sides)

SPECIFICATIONS	FC3440DXL	
	mm	inch
W	760	29.9
D	490	19.3
H	1090	42.9
H (w/o 4" caster)	990	39.1

FUNC-CART SERIES

- PP top and handles
- 4 Aluminium frames
- 4" casters
- FC2811 / FC2821 / FC2813 with 3-side panels & ABS door w/key lock
- FC2801 / FC2803 / FC2805 / FC2807 with 3-side panels



FC28 can attach the waste bin as the photo

ABS door w/key lock



FC2811



FC2800



FC2802



FC2804



FC2801



FC2813



FC2821

SPECIFICATIONS

FC2800

FC2801 (w/ 3-side panels)

FC2811 (w/ 3-side panels & ABS door w/key lock)

FC2821 (w/ 3-side panels & ABS door w/key lock)

FC2802

FC2803 (w/ 3-side panels)

FC2813 (w/ 3-side panels & ABS door w/key lock)

FC2804

FC2805 (w/ 3-side panels)

FC2806

FC2807 (w/ 3-side panels)

	mm	inch	mm	inch	mm	inch	mm	inch
W (w/ handles)	900	35.4	900	35.4	900	35.4	900	35.4
W	760	29.9	760	29.9	760	29.9	760	29.9
D	490	19.3	490	19.3	490	19.3	490	19.3
H	1040	40.9	1040	40.9	935	36.8	935	36.8
H (w/o 4" caster)	940	37.2	940	37.2	835	32.8	835	32.8
Caster	4"		4"		4"		4"	
Tray: L	720	28.4	720	28.4	720	28.4	720	28.4
Tray: W	450	17.7	450	17.7	450	17.7	450	17.7



FC2806

UTILITY CART

- 4 Aluminium frames
- 4" TPR casters. (2 swivels, 2 brakes)
- PP shelf can be cleaned and assembled easily
- Sized to carry different loads
- Supplied in knock down form
- Durable and multi-use cart for in houses, factories and all working conditions



UC2530



UC3120



UC3130



UC4330

UC4320
UC4320P
(w/ 3-side panels)

UC4330P
(w/ 3-side panels)

SPECIFICATIONS

	UC2530		UC3120		UC3130		UC4320 UC4320P (w/ 3-side panels)		UC4330		UC4330P (w/ 3-side panels)	
	mm	inch	mm	inch	mm	inch	mm	inch	mm	inch	mm	inch
W	655	25.8	790	31.1	790	31.1	1100	43.3	1100	43.3	1100	43.3
D	370	14.6	480	18.9	480	18.9	520	20.5	520	20.5	520	20.5
H	900	35.4	950	37.4	1000	39.4	950	37.4	1020	40.2	1020	40.2
H (w/o 4" caster)	824	32.6	850	33.6	900	35.4	850	33.6	920	36.4	920	36.4
Caster	3"		4"		4"		4"		4"		4"	
Tray: L	485	19.1	620	24.4	620	24.4	915	36.0	915	36.0	915	36.0
Tray: W	365	14.4	450	17.7	450	17.7	520	20.5	520	20.5	520	20.5
N.W. / G.W. (kg)	8.0 / 9.0		8.0 / 10.0		11.0 / 12.0		12.5 / 15.0		16.5 / 19.0		20.5 / 23.0	
Carton (mm)	576L / 409W / 200H		712L / 509W / 180H		712L / 509W / 236H		991L / 552W / 200H		991L / 600W / 279H		991L / 600W / 279H	



UC4330P

EQUIPMENT CART

All EC models are well designed and high quality; with 4 castors 100 mm dia., 2 castors of which are lockable. The height of each shelf & each drawer is adjustable to fit your needs.

- Mount profile: aluminium
- Drawer/shelf: metal w/ powder coated, height adjustable
- Push handle: steel tube w/ powder coated
- Drawer/shelf cover: ABS
- Base cover: ABS
- Drawer rail: auto return



- Pole height adjustable by stepping
- Height range: 310mm (12")
- w/push handle and 4" plastic casters
- Dimension:
W413 x D356 x H900~1210mm (w/ 4" casters)
W523 x D550 x H900~1210mm (w/ 4" casters & bumpers)



AEC4714

SPECIFICATIONS

EC5311 / EC5330 / EC5302 / EC5314

Cart dimensions (mm)	W500 x D610 x H1350 (w/ 4" casters) (EC5311)
Aluminium profile height (mm)	1230 / 1170 (above the base)
Drawer dimensions (mm)	W455 x D360 x H140
Shelf dimensions (mm)	W455 x D360 x H30
Cart weight (kg)	35 (EC5311)
Drawer load limit (kg)	10
Shelf load limit (kg)	10
Caster dimensions	4" steel casters (100mm, 2 w/ brake) Anti-static casters available at additional charge.



- EVC**
VESA connector, height adjustable
- Material: steel
 - Weight capacity: ~8kg (17.6 lbs)
 - Rotation: 270°
 - Pivot: 180°
 - VESA: 75 / 100mm

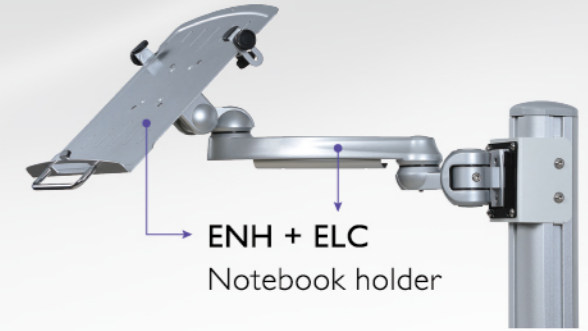

EIP + ELC
iPad holder

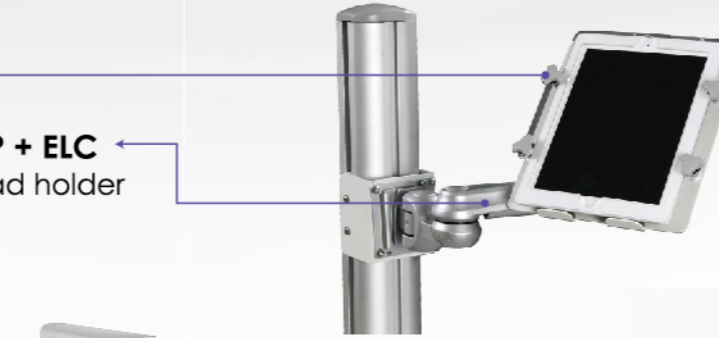

- ELC**
Monitor long arm, height adjustable
- Material: steel
 - Max weight: 10kg
 - Max length: 25cm
 - VESA: 75 / 100mm

- EKB**
Key board & mouse holder, height adjustable
- Tilt: 180°
 - Material: aluminum alloy
 - Extension: 540 mm



- EHL**
Push handle, metal with powder coating, height adjustable



- EPH**
Probe holder

- EBH**
Bottle holder



- EBB**
Utility wire basket, height adjustable (20 x 20 x 15cm)



CLEAN LINEN TROLLEY

- Smooth design and easy to clean
- Durable construction
- Fixed three shelves and top tray
- Two push handles
- PPR bumper
- CL5604 opens on both sides for easy access
- CCL5604B w/ the back



CL5604



CL5604B (with back)

SPECIFICATIONS

CL5604 / CL5604B (with back)

Material	Steel with powder coating, white
Overall (mm)	L1000 x W625 x H1431(w/o push handle)
Shelf size (mm)	L1000 x W500
Caster	6" steel casters (2 swivel & 2 w/ brake) provide convenient mobility

OVERBED TABLE

This smart design of overbed table is suitable for use with beds and chairs. Easy clean seamless table provides pleased using experience. It is stable, easy to assemble and simple to operate safely.

- Table material: PE (max. load 20kg)
Table dimension: 900 x 430mm, thickness: 34mm
- Table height is adjustable (not tilt)
- Height range using a gas lift (725 ~1,050mm, floor to top, including 2" casters)
- Aluminum pole & stylish elliptic tube in silver (base)
- The base distance between two ends is 750mm
- Caster: 2" plastic twin casters (2 w/brake, 2 free)



SPECIFICATIONS

BT 38

	mm	inch
W	900	35.4
D	430	16.9
H	725~1050	28.5~41.3



PEDIATRIC EMERGENCY CART



MX37EMGP2

- Metal with powder coating
- ABS top, bumper & sliding table
- Drawer: 3" x 8 + 6" x 1, central key lock
- Drawers are Color Coded using for emergency pediatric care
- Various accessories and drawer divider sets are available
- Lock options: One locking bar for all drawers (MX37EMGP1)
9 x individual breakaway lock (MX37EMGP2)
- Caster: 5" (125mm) Steel casters (2 w/brake, 1 free,
1 w/direction control) (standard)



MX37EMGP1

SPECIFICATIONS

MX37EMGP1 MX37EMGP2

	mm	inch
W	690	27.2
D	518	20.4
H	1085	42.7
H (w/o 5" Casters)	951	37.4



MACHAN INTERNATIONAL CO., LTD.

No.65, Lane 706, Erkan Rd., Waipu Dist.,

Taichung City 438, Taiwan

Tel: +886-4-2688-7171

Fax: +886-4-2688-5050

sales@bailida-medical.com

www.bailida-medical.com

CE ISO 9001:2000